

1T9723DA | CTEVO TUBE 140

LED Ceiling-, suspension- or track mounted fixture

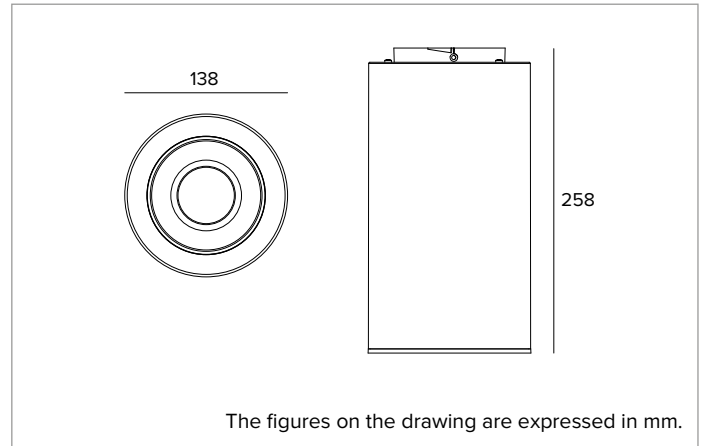

	3000K	H(m)	D(m)	Emax(lx)		
	Ra90		61°			
Fixture Power	13W	1	1.18	1285		
Source Flux	1731lm	2	2.36	321		
Fixture Flux	1272lm	3	3.55	143		
Efficacy	97lm/W	4	4.73	80		
TS1538	Imax=776cd/klm	Imax	1344cd	5	5.91	51



SOURCE

High efficiency Chip on Board LED Ra90. Ra80 on request.

Energy efficiency class: E

Nominal power: 11,6W

Nominal flux: 1731lm

Colour rendering index: 90

Rf: 92

Rg: 101

CCT nominal: 3000K

Lifetime (L80/B10): >50000h tq +25°C

ILLUMINOTECHNICAL CHARACTERISTICS

Decorative cut-off ring in thermoplastic material. Low luminance deep UGR optic for high visual comfort. Optic composed of a deep thermoplastic reflector with reflective metallisation and a protective anti-scratch coating, a holographic acrylic diffuser screen and a highly reflective white thermoplastic internal recuperator. UGR<19 and L65<1000 cd/m² (EN 12464-1).

Optic: REFLECTOR

Beam angles: WFL (UGR)

Optical efficiency: 73%

Fixture flux: 1272lm

Luminous efficacy: 97lm/W

Photobiological safety: Compliant with RG1 low risk group

MECHANICAL CHARACTERISTICS

Painted aluminium body. Galvanized steel Internal structure and passive heat sink in die-cast aluminum with protective cataphoresis treatment.

Colour and finish: Deep black

Weight: 1.05Kg

Degree of protection: IP20

ELECTRICAL CHARACTERISTICS

Dimmable DALI driver integrated in the body of the fixture. Luminaire compliant with EN 60598-2-22 for power supply from a centralised emergency system CPSS (Central Power Supply System), not incorporated in the luminaire - high risk areas excluded. The default power and flux are 100% in AC and 100% in DC.

Fixture Power: 13W

Power supply: 230Vac 50Hz

Insulation Class: CLASS 1

Type of driver / Control: DALI - PUSH

Driver included: YES

Class F: YES

SAFE FLICKER: PstLM=<1 and SVM=<0.4 (IEC TR 61547-1 and IEC TR 63158), to ensure a more comfortable and safe light

Ambient temperature: 0°C / +25°C

INSTALLATION

To be completed with ceiling, suspension or track mounting system.

NOTES

Casambi control system available using a dedicated accessory. Commissioning of the control system via free APP; the intervention of a specialist technician can be quoted on request.

WARRANTY

5 years.

WARNING

Luminaire designed for disposal/recycling at end-of-life. Replaceable (LED only) light source by a professional. Replaceable control gear by a professional.

Due to the technological evolution of the electronic components, the data provided may be updated, and as such, confirmation must be requested during the order process.

Luminous flux and power supply have +/-10% tolerances with respect to the indicated value. tq +25°C (CIE 121).

We reserve the right to make technical changes.

Targetti Sankey S.r.l.
Via Pratese, 164
50145 Firenze - Italy
Tel: +39 055 37911
targetti.com
targetti@targetti.com

CCIAA Firenze
Share Capital:
€ 500.000,00
VAT N. (IT):
01537660480
R.E.A.: FI-275656

TARGETTI

1T9723DA | CCTEVO TUBE 140

LED Ceiling-, suspension- or track mounted fixture

Related codes

Mounting System



Colour	Code
●	1T9735

Ceiling mounting kit.
For CCTEVO Tube 140.



L mm	Driver	Colour	Code
2000	DALI	●	1T9737DA

Suspension kit.
For CCTEVO Tube 140.

Mounting System



Driver	Colour	Code
DALI	●	1T9731DA

Kit for track installation.
For CCTEVO Tube 140.

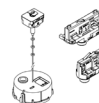

L mm	Driver	Colour	Code
2000	DALI	●	1T9733DA

Track suspension kit.
For CCTEVO Tube 140.

Accessories

Control systems



Code

1T5349

IP20 wireless control unit with DALI interface.
It generates a local DALI2 bus, enabling a direct connection to a DALI interface LED driver.

The module can only be used in a closed system and cannot be connected to an existing DALI network.

The module is wireless controlled using a Casambi app for smartphones and tablets using Bluetooth 5.0 technology.

The devices automatically create an adaptive, robust, and reliable wireless mesh network, allowing for the easy and efficient management of a high number of fixtures. The control unit is preset to the DALI 1CH profile, meaning the device can control a single DALI driver with broadcast commands.

In addition to the DALI broadcast, other operating modes are available, such as:

- Button (normally open)
- Control unit 0/1-10V
- Control unit DALI Tunable White DT8
- Presence sensor



Code

2T0131

IP20 Extender for wireless control of LED driver with dimming DALI (or 1-10V) interface based on Casambi technology.

It has a DALI2 output with the capacity to control up to 40 lighting fixtures.

With the addition of a further external BUS DALI power supply it is possible to control up to 64 fixtures.

IP20 Extender is preset to the DALI broadcast profile, meaning all the luminaires connected to it are dimmable at the same level.

In addition to the DALI broadcast other operating modes are available, such as:

- EXTENDER DALI 8CH
- EXTENDER DALI Tunable White
- EXTENDER 0/1-10V
- EXTENDER DALI 4CH
- EXTENDER DALI DT8 Tunable White

Due to the technological evolution of the electronic components, the data provided may be updated, and as such, confirmation must be requested during the order process.

Luminous flux and power supply have +/-10% tolerances with respect to the indicated value. tq +25°C (CIE 121).

We reserve the right to make technical changes.

Targetti Sankey S.r.l.
Via Pratese, 164
50145 Firenze - Italy
Tel: +39 055 37911
targetti.com
targetti@targetti.com

CCIAA Firenze
Share Capital:
€ 500.000,00
VAT N. (IT):
01537660480
R.E.A: FI-275656

TARGETTI